

# D-Thread



## Mill-Thread Inserts and Toolholders for machining deep threads

- Improved productivity due to multi-insert toolholders.
- Partial Profile, standard or U-type inserts for a wide range of threads.
- Inserts with three cutting edges, reduces tooling costs.
- Low cutting resistance due to the single point inserts.
- Holder allows for a long overhang and includes internal coolant.
- Same insert and toolholder for both external and internal thread.

### Contents:

### Page:

Standard Toolholders and Inserts  
U-Type Toolholders and Inserts

158  
159-160

## D-Thread Mill-Thread Inserts & Toolholders for machining deep threads

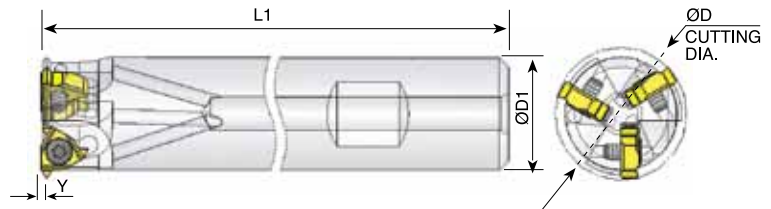

Ordering Code	Insert Size		Y	D	D1	L1	No. of Inserts	Insert Screw	Torx Key
	L	I.C							
<b>SR0023Q11</b>	11	1/4	1	23.5	20	190	3	SE11	K11

### Partial 60° Size 11

Ordering Code		Pitch	
		mm	TPI
<b>11 60D</b>	<b>INT.</b>	1.0 - 2.0	24 - 12
	<b>EX.</b>	0.75 - 1.5	32 - 14

Coated Grade: BMA

### Partial 55° Size 11

Ordering Code		Pitch TPI
<b>11 55D</b>	<b>INT./EX.</b>	24 - 14

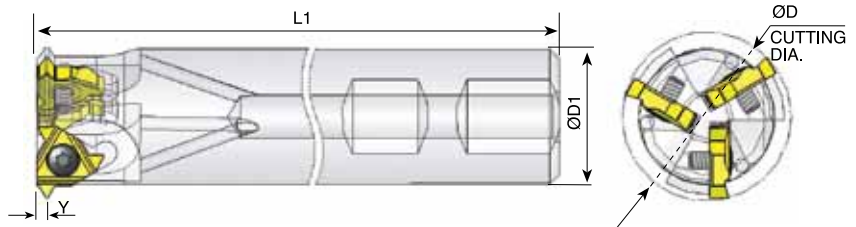
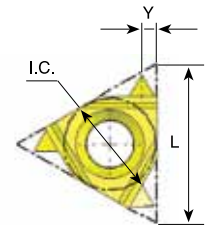

Ordering Code	Insert Size		Y	D	D1	L1	No. of Inserts	Insert Screw	Torx Key
	L	I.C							
<b>SR0031R16</b>	16	3/8	1.8	31	25	225	3	SE16	K16

### Partial 60° Size 16

Ordering Code		Pitch	
		mm	TPI
<b>16 60D</b>	<b>INT.</b>	2.5 - 3.5	10 - 7
	<b>EX.</b>	2.0 - 3.0	12 - 8

Coated Grade: BMA

### Partial 55° Size 16

Ordering Code		Pitch TPI
<b>16 55D</b>	<b>INT./EX.</b>	12 - 8

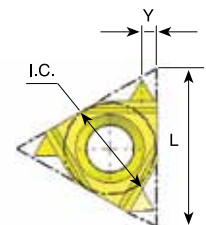

## D-Thread Mill-Thread Inserts & Toolholders for machining deep threads

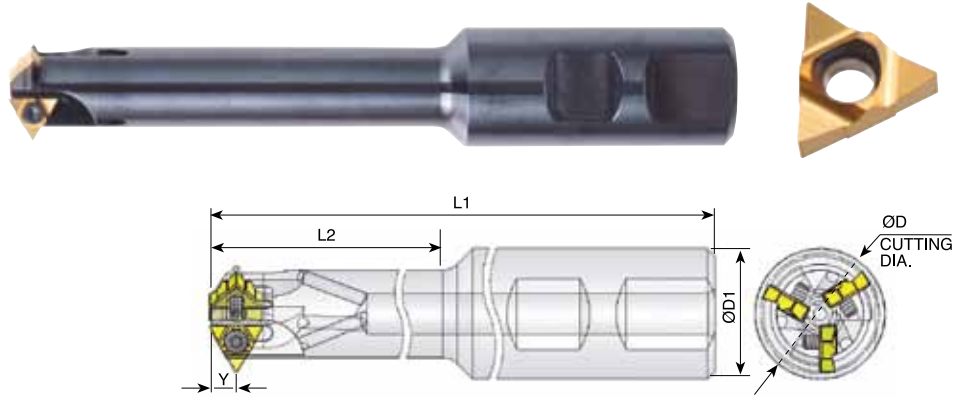

Ordering Code	Insert Size		Y	D	D1	L1	L2	No. of Inserts	Insert Screw	Torx Key
	L	I.C.								
<b>SR0023M11U</b>	11U	1/4U	5	23	25	150	88	3	SE11	K11

### Partial 60° Size 11U

Ordering Code		Pitch	
		mm	TPI
<b>11U 60D</b>	<b>INT.</b>	2.5 - 4.0	10 - 6
	<b>EX.</b>	2.0 - 3.0	12 - 8
<b>11U 60D-18-12</b>	<b>INT.</b>	1.5 - 2.0	18 - 12
	<b>EX.</b>	1.25 - 1.75	20 - 14

Coated Grade: BMA

### Partial 55° Size 11U

Ordering Code		Pitch TPI
<b>11U 55D</b>	<b>INT./EX.</b>	12 - 7

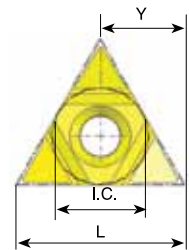

## D-Thread Mill-Thread Inserts & Toolholders for machining deep threads

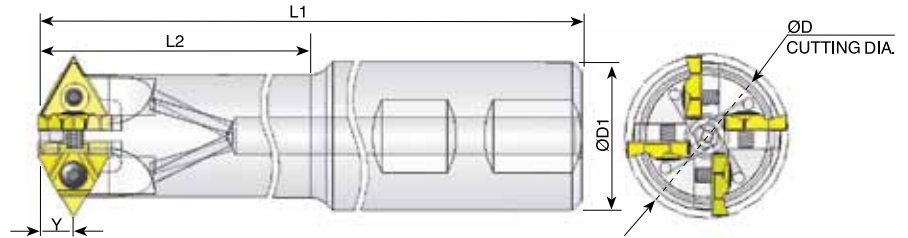

Ordering Code	Insert Size		Y	D	D1	L1	L2	No. of Inserts	Insert Screw	Torx Key
	L	I.C								
<b>SR0035R16U</b>	16U	3/8U	7.6	35.5	32	220	155	4	SE16	K16

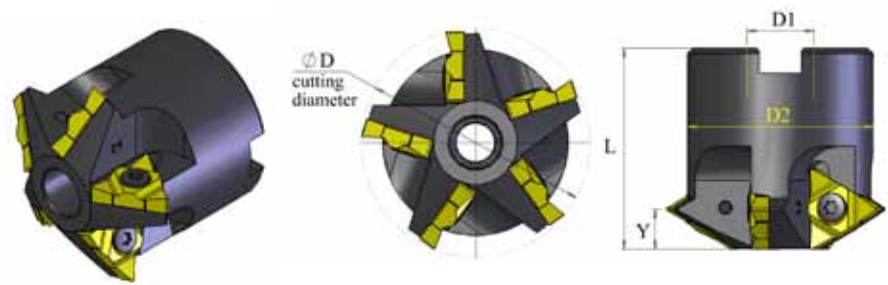

Ordering Code	Insert Size		Y	D	D1	D2	L	No. of Inserts	Insert Screw	Torx Key
	L	I.C								
<b>SR0043B16U-5</b>	16U	3/8U	7.6	43.4	16	35.3	38.1	5	SE16	K16

### Partial 60° Size 16U

Ordering Code		Pitch	
		mm	TPI
<b>16U 60D</b>	<b>INT.</b>	4.0 - 6.0	6 - 4
	<b>EX.</b>	3.0 - 5.0	8 - 5
<b>16U 60D-16-8</b>	<b>INT.</b>	1.5 - 3.0	16 - 8
	<b>EX.</b>	1.5 - 2.5	18 - 10

### Partial 55° Size 16U

Ordering Code		Pitch TPI
<b>16U 55D</b>	<b>INT./EX.</b>	6 - 4.5

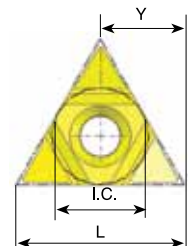

Coated Grade: BMA