

Mill - Thread Inserts and Kits



Mill-Thread tools for threading on CNC milling machines by using helical interpolation programs

Advantages of Mill-Thread Tools

- Same toolholder and insert can produce both right-hand and left-hand threads.
- A single insert & toolholder can produce a given thread on many diameters (External & Internal).
- Prismatic shape of insert's tail ensures exact and reliable clamping in the toolholder.
- Most inserts are double sided, having two cutting edges.
- Thread is produced in one tool pass.
- MT tools can produce tapered threads.
- Improved productivity thanks to increased cutting speeds and multitooth type carbide inserts.
- Threading to one pitch of a shoulder in a blind hole.
- Longer tool life thanks to a special multilayer coating process.
- Lower tooling costs, considerably less expensive than using taps and dies.
- Since lower machine power is required, a smaller machine can produce larger threads in a single operation with less idle time and tool changes.

Contents:

Product Identification
ISO
UN
WHIT
BSPT
NPT
NPTF
NPS
NPSF

Page:

140
141
142
143
143
144
144
145
145

Contents:

PG - DIN 40430
UNJ
American Buttress
Acme
Internal ISO Kits
Special Tools

Page:

146
146
147
147
148
149

Product Identification

Mill-Thread Inserts Ordering Codes

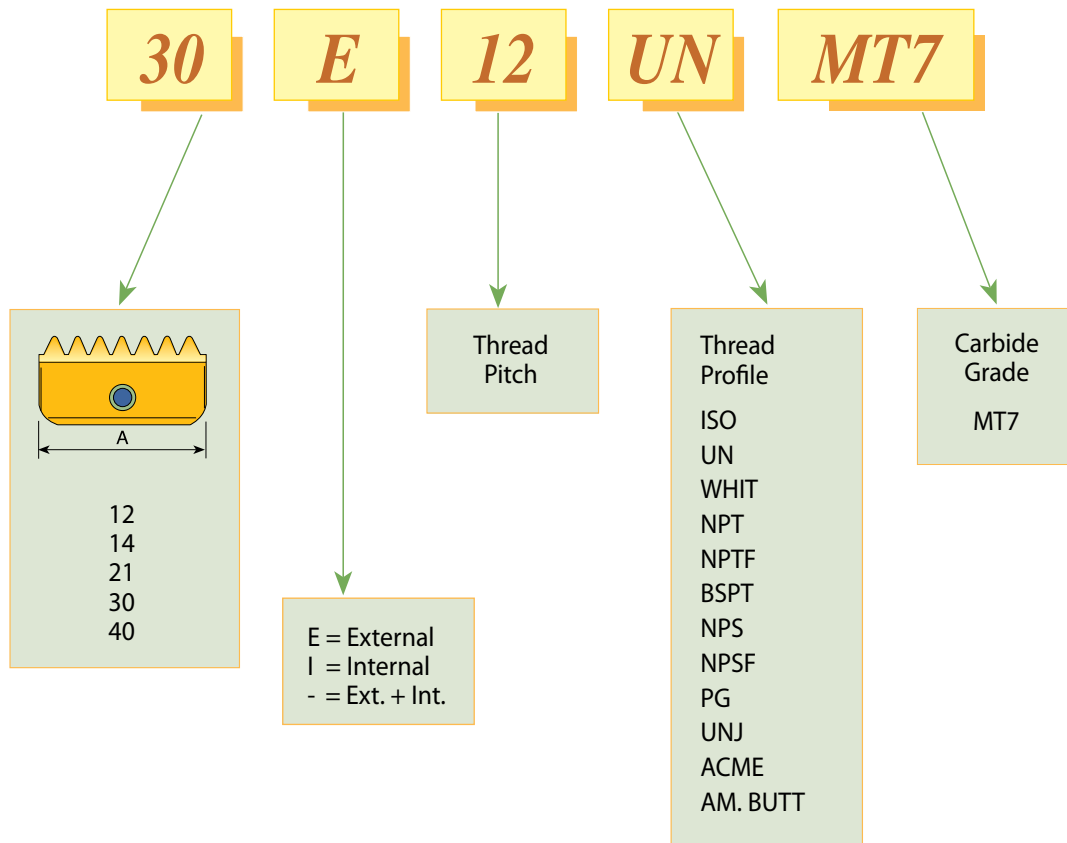

ISO

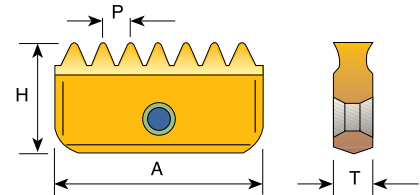
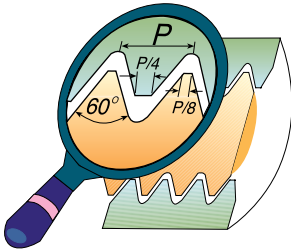

Pitch mm		Insert Size = A					
		12	14	21	30	40	
0.5	Ext.						
0.5	Int.	* 12 0.5 ISO	14 0.5 ISO				
0.75	Ext.		14 E 0.75 ISO				
0.75	Int.	* 12 0.75 ISO	14 0.75 ISO				
1.0	Ext.		14 E 1.0 ISO	21 E 1.0 ISO			
1.0	Int.	* 12 1.0 ISO	14 1.0 ISO	21 1.0 ISO			
1.25	Ext.		14 E 1.25 ISO				
1.25	Int.	* 12 1.25 ISO	14 1.25 ISO				
1.5	Ext.		14 E 1.5 ISO	21 E 1.5 ISO	30 E 1.5 ISO	40 E 1.5 ISO	
1.5	Int.	* 12 1.5 ISO	14 1.5 ISO	21 1.5 ISO	30 1.5 ISO	40 1.5 ISO	
1.75	Ext.		14 E 1.75 ISO				
1.75	Int.		14 1.75 ISO	21 1.75 ISO			
2.0	Ext.		14 E 2.0 ISO	21 E 2.0 ISO	30 E 2.0 ISO	40 E 2.0 ISO	
2.0	Int.		14 2.0 ISO	21 2.0 ISO	30 2.0 ISO	40 2.0 ISO	
2.5	Ext.		14 E 2.5 ISO	21 E 2.5 ISO			
2.5	Int.		14 2.5 ISO	21 2.5 ISO			
3.0	Ext.			21 E 3.0 ISO	30 E 3.0 ISO	40 E 3.0 ISO	
3.0	Int.			21 3.0 ISO	30 3.0 ISO	40 3.0 ISO	
3.5	Ext.				30 E 3.5 ISO		
3.5	Int.			21 3.5 ISO	30 3.5 ISO	40 3.5 ISO	
4.0	Ext.				30 E 4.0 ISO	40 E 4.0 ISO	
4.0	Int.				30 4.0 ISO	40 4.0 ISO	
4.5	Ext.						
4.5	Int.				30 4.5 ISO	40 4.5 ISO	
5.0	Ext.					40 E 5.0 ISO	
5.0	Int.					30 5.0 ISO	40 5.0 ISO
5.5	Ext.						
5.5	Int.					30 5.5 ISO	40 5.5 ISO
6.0	Ext.						40 E 6.0 ISO
6.0	Int.						40 6.0 ISO
H		6.3	7.5	12	16	20	
T		2.9	3.1	4.7	5.5	6.3	

Order example: 14 | 1.5 ISO MT7

* One cutting edge

UN UNC, UNF, UNEF, UNS

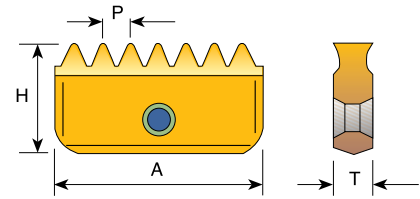
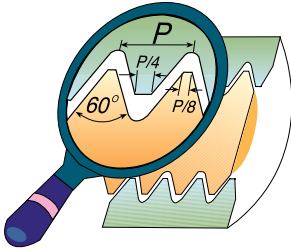

Pitch TPI		Insert Size = A				
		12	14	21	30	40
32	Ext.		14 E 32 UN			
32	Int.	* 12 32 UN	14 32 UN			
28	Ext.		14 E 28 UN			
28	Int.	* 12 28 UN	14 28 UN			
27	Ext.					
27	Int.		14 27 UN			
24	Ext.		14 E 24 UN	21 E 24 UN		
24	Int.	* 12 24 UN	14 24 UN	21 24 UN		
20	Ext.		14 E 20 UN	21 E 20 UN	30 E 20 UN	
20	Int.	* 12 20 UN	14 20 UN	21 20 UN	30 20 UN	
18	Ext.		14 E 18 UN	21 E 18 UN	30 E 18 UN	
18	Int.	* 12 18 UN	14 18 UN	21 18 UN	30 18 UN	
16	Ext.		14 E 16 UN	21 E 16 UN	30 E 16 UN	40 E 16 UN
16	Int.	* 12 16 UN	14 16 UN	21 16 UN	30 16 UN	40 16 UN
14	Ext.		14 E 14 UN	21 E 14 UN	30 E 14 UN	40 E 14 UN
14	Int.		14 14 UN	21 14 UN	30 14 UN	40 14 UN
12	Ext.		14 E 12 UN	21 E 12 UN	30 E 12 UN	40 E 12 UN
12	Int.		14 12 UN	21 12 UN	30 12 UN	40 12 UN
11	Ext.		14 E 11 UN	21 E 11 UN		
11	Int.		14 11 UN			
10	Ext.		14 E 10 UN	21 E 10 UN	30 E 10 UN	40 E 10 UN
10	Int.		14 10 UN	21 10 UN	30 10 UN	40 10 UN
9	Ext.					
9	Int.		** 14 9 UN			
8	Ext.				30 E 8 UN	40 E 8 UN
8	Int.			21 8 UN	30 8 UN	40 8 UN
7	Ext.					
7	Int.			21 7 UN		
6	Ext.				30 E 6 UN	40 E 6 UN
6	Int.				30 6 UN	40 6 UN
5	Ext.					
5	Int.				30 5 UN	
4.5	Ext.					
4.5	Int.					40 4.5UN
4	Ext.					
4	Int.					40 4 UN
H		6.3	7.5	12	16	20
T		2.9	3.1	4.7	5.5	6.3

Order example: 21 | 18 UN MT7

* One cutting edge

** Cannot be used with carbide shank Toolholders.

WHIT BSW, BSF, BSP

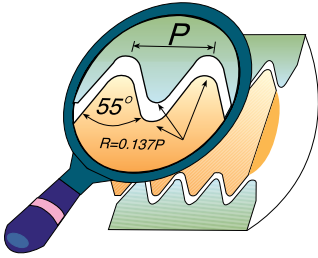

Same Insert for External and Internal thread.

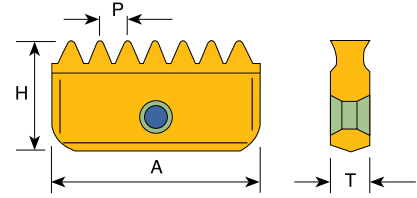

Pitch TPI	Insert Size = A				
	12	14	21	30	40
24		14-24 W			
20		14-20 W	21-20 W		
19	* 12 - 19 W	14-19 W	21-19 W		
16		14-16 W	21-16 W	30-16 W	
14		14-14 W	21-14 W	30-14 W	
11		14-11 W	21-11 W	30-11 W	40-11 W
8					40- 8 W
H	6.3	7.5	12	16	20
T	2.9	3.1	4.7	5.5	6.3

* One cutting edge

Order example: 21-11 W MT7

BSPT

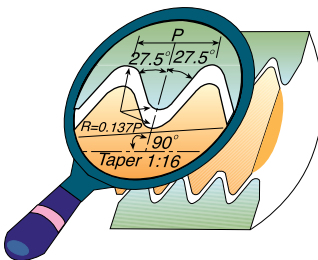

Conical pipe thread inserts are one-sided and may be used for both External and Internal threading.

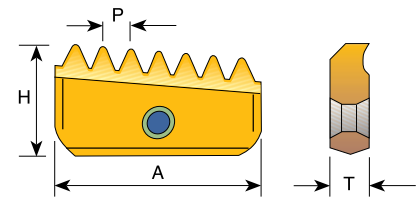

Pitch TPI	Insert Size = A				
	12	14	21	30	40
19	12-19 BSPT	14-19 BSPT			
14		14-14 BSPT	21-14 BSPT		
11			21-11 BSPT	30-11 BSPT	40-11 BSPT
H	6.3	7.5	12	16	20
T	2.9	3.1	4.7	5.5	6.3

Order example: 14-19 BSPT MT7

For conical preparation end mills see page 221

NPT

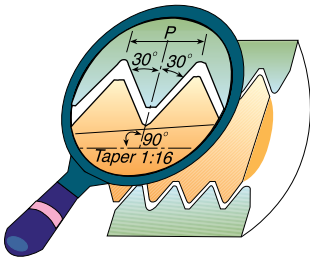

Conical pipe thread inserts are one-sided and may be used for both External and Internal threading.

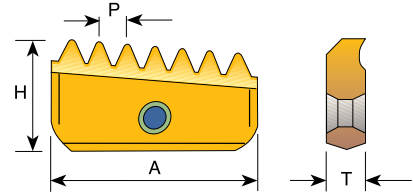

Pitch TPI	Insert Size = A				
	12	14	21	30	40
18	12-18 NPT	14-18 NPT			
14		14-14 NPT	21-14 NPT		
11.5			21-11.5 NPT	30-11.5 NPT	40-11.5 NPT
8				30- 8 NPT	40- 8 NPT
H	6.3	7.5	12	16	20
T	2.9	3.1	4.7	5.5	6.3

Order example: 30-11.5 NPT MT7

NPTF

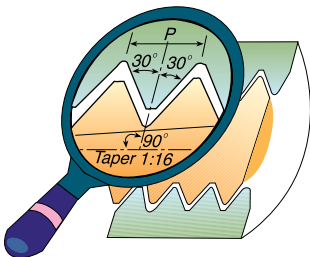

Conical pipe thread inserts are one-sided and may be used for both External and Internal threading.

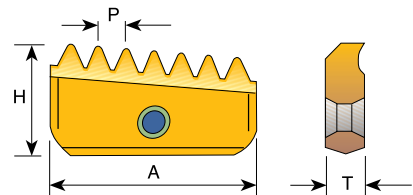

Pitch TPI	Insert Size = A				
	12	14	21	30	40
18	12-18 NPTF	14-18 NPTF			
14		14-14 NPTF	21-14 NPTF		
11.5			21-11.5 NPTF	30-11.5 NPTF	40-11.5 NPTF
8				30- 8 NPTF	40- 8 NPTF
H	6.3	7.5	12	16	20
T	2.9	3.1	4.7	5.5	6.3

Order example: 21-14 NPTF MT7

For conical preparation end mills see page 221

NPS

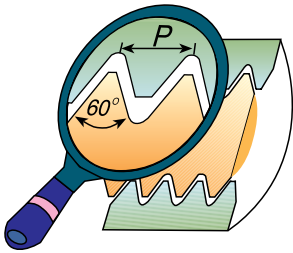

Same Insert for External and Internal thread

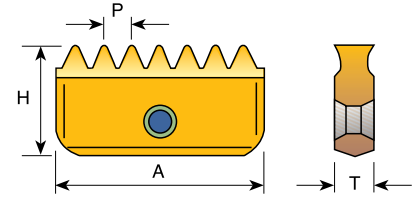

Pitch TPI	Insert Size = A				
	12	14	21	30	40
18	* 12-18 NPS	14-18 NPS			
14		14-14 NPS	21-14 NPS		
11.5			21-11.5 NPS	30-11.5 NPS	40-11.5 NPS
8				30- 8 NPS	40- 8 NPS
H	6.3	7.5	12	16	20
T	2.9	3.1	4.7	5.5	6.3

Order example: 30-11.5 NPS MT7

* One cutting edge

NPSF

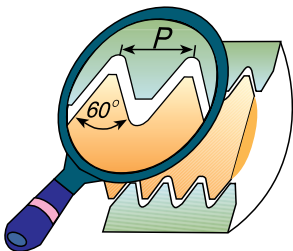

Same Insert for External and Internal thread

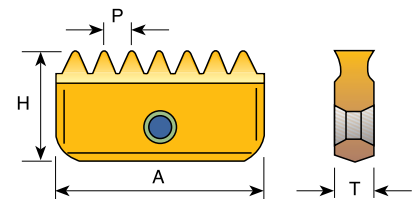

Pitch TPI	Insert Size = A				
	12	14	21	30	40
18	* 12-18 NPSF	14-18 NPSF			
14		14-14 NPSF	21-14 NPSF		
11.5			21-11.5 NPSF	30-11.5 NPSF	40-11.5 NPSF
8				30- 8 NPSF	40- 8 NPSF
H	6.3	7.5	12	16	20
T	2.9	3.1	4.7	5.5	6.3

Order example: 21-14 NPSF MT7

* One cutting edge

PG - DIN 40430

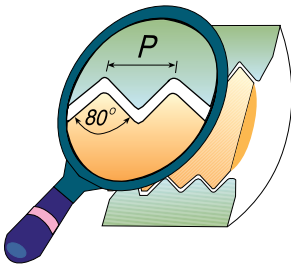

Same Insert for External and Internal thread

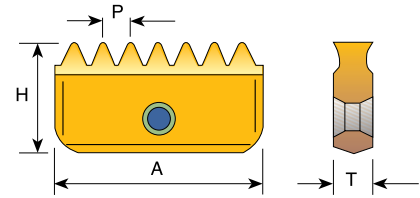

Pitch TPI	Insert Size = A		
	14	21	30
18	14-18 PG (PG 9, 11, 13.5, 16)	21-18 PG (PG 16)	
16		21-16 PG (PG 21, 29, 36, 42, 48)	30-16 PG (PG 36, 42, 48)
H	7.5	12	16
T	3.1	4.7	5.6

Order example: 21-18 PG MT7

UNJ

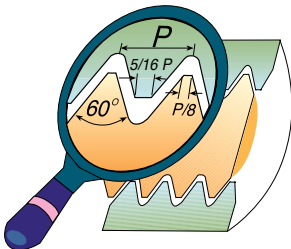

Inserts for External thread

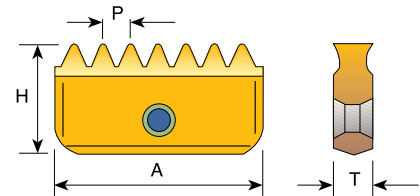

Pitch TPI		Insert Size = A	
		14	21
24	Ext.	14 E 24 UNJ	21 E 24 UNJ
20	Ext.	14 E 20 UNJ	21 E 20 UNJ
18	Ext.	14 E 18 UNJ	21 E 18 UNJ
16	Ext.	14 E 16 UNJ	21 E 16 UNJ
14	Ext.	14 E 14 UNJ	21 E 14 UNJ
12	Ext.	14 E 12 UNJ	21 E 12 UNJ
H		7.5	12
T		3.1	4.7

Order example: 21E 16 UNJ MT7

For internal UNJ threads it is common to use UN inserts as partial profile.

American Buttress

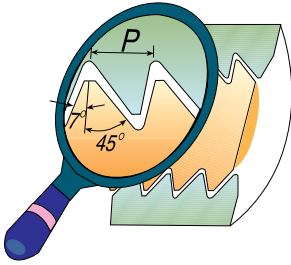

ABUT thread inserts are one-sided and may be used for both External and Internal threading

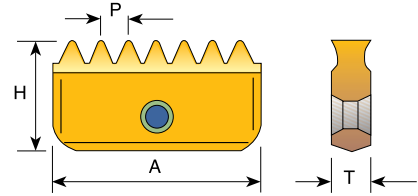

Pitch TPI	Insert Size = A		
	21	30	40
16	21 - 16 ABUT	30 - 16 ABUT	
12	21 - 12 ABUT	30 - 12 ABUT	
10	21 - 10 ABUT	30 - 10 ABUT	
8	21 - 8 ABUT	30 - 8 ABUT	
6		30 - 6 ABUT	
4		* 30 - 4 ABUT	40 - 4 ABUT
H	12	16	20
T	4.7	5.6	6.3

Order example: 30 - 6 ABUT MT7

* Inserts to be used only on Multi-Insert toolholders see page 155

ACME

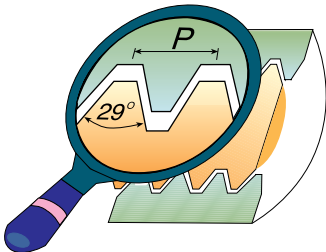

Inserts for Internal threads

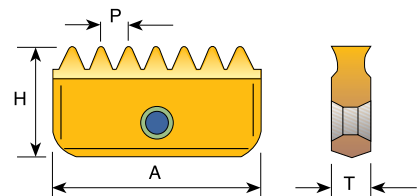

Pitch TPI		Insert Size = A		
		21	30	40
12	Int.	21 12 ACME	30 12 ACME	
10	Int.	21 10 ACME	30 10 ACME	
8	Int.	21 8 ACME	30 8 ACME	
6	Int.		30 6 ACME	
5	Int.		30 5 ACME	
4	Int.		* 30 4 ACME	40 4 ACME
3.5	Int.			40 3.5 ACME
3	Int.			** 40 3 ACME
H		12	16	20
T		4.7	5.6	6.3

Order example: 21 | 8 ACME MT7

* Inserts to be used only on Multi-Insert toolholders see page 155

** One cutting edge

Internal ISO Kits



MTK 12 ISO	MTK 14 ISO
<u>INSERTS</u>	<u>INSERTS</u>
12 0.75 ISO	14 1.0 ISO 2 Pcs
12 1.0 ISO 2 Pcs	14 1.5 ISO 2 Pcs
12 1.25 ISO	14 2.0 ISO 2 Pcs
12 1.5 ISO 2 Pcs	
<u>TOOLHOLDER</u>	<u>TOOLHOLDER</u>
SR 0009 H12	SR 0017 H14
<u>KEY</u>	<u>KEY</u>
K12	K14
<u>SCREW</u>	<u>SCREW</u>
S12	S14

Order example : MTK 14 | ISO

Special Tools



In addition to standard products, C.P.T. manufactures special tools and inserts according to customers' requests. Special tools are supplied in short delivery times.

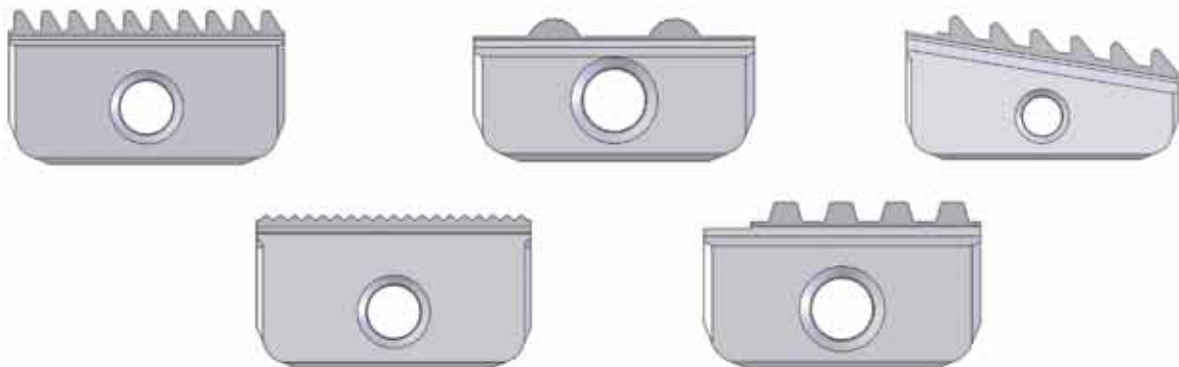

Mill-Thread Toolholders



Contents:

Page:

Product Identification	152
Single Insert Toolholders	153
Long Shank Toolholders	153
Twin Insert Toolholders	154
Multi Insert Toolholders	155
External Multi Insert Toolholders	155
Long Carbide Shank Toolholders	156
Carbide Shank Toolholders for Single Point Threading	156

Product Identification

Mill-Thread Toolholders Ordering Codes

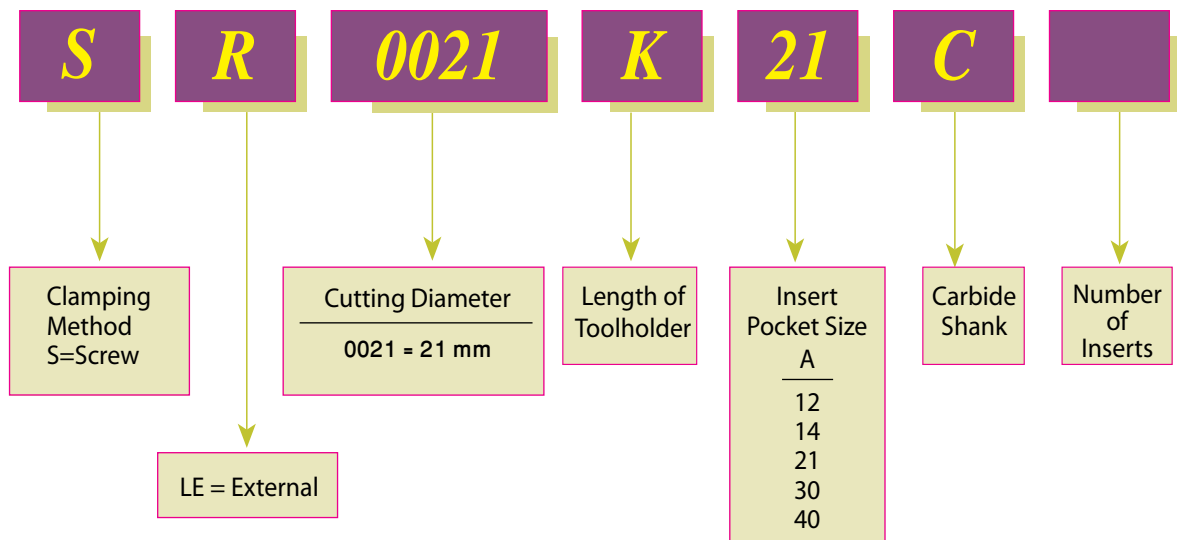

Single Insert Toolholders

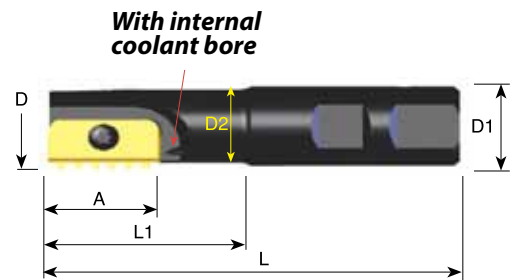

Ordering Code	A	D	D1	D2	L	L1	Insert Screw	Torx Key
* SR0009H12	12	9.5	20	7.5	85	14	S12	K12
SR0010H12	12	9.9	20	7.6	85	16	S12	K12
SR0012F14	14	12.0	20	8.9	75	20	S14	K14
SR0014H14	14	14.5	20	11.2	85	25	S14	K14
SR0017H14	14	17.0	20	13.4	85	30	S14	K14
** SR0018H21	21	18.0	20	14.4	85	30	S21	K21
SR0021H21	21	21.0	20	16.5	94	40	S21	K21
SR0029J30	30	29.0	25	22.4	110	50	S30	K30
SR0048M40	40	48.0	40	35.0	153	78	S40	K40

Order example: SR0029J30

* Not for conical inserts: 12-18 NPT, 12-18 NPTF, 12-19 BSPT

** Cannot be used with the following inserts:

21 I 3.5 ISO, 21 I 8 UN, 21 I 7 UN, 21-11 BSPT, 21-11.5 NPT, 21-11.5 NPTF

Long Shank Toolholders

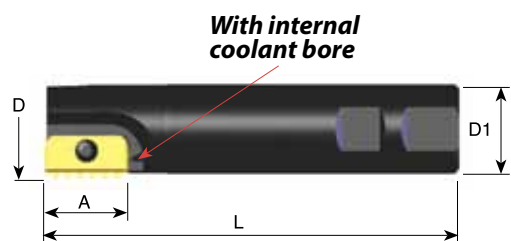

Ordering Code	A	D	D1	L	Insert Screw	Torx Key
SR0025K21	21	25	20	125	S21	K21
SR0031M30	30	31	25	150	S30	K30
SR0038M30	30	38	32	150	S30	K30
SR0048R40	40	48	40	210	S40	K40

Order example: SR0031M30

For holders with long overhang reduce the cutting speed and feed rate between 20% to 40% (depends on workpiece material, pitch and overhang)

Twin Insert Toolholders

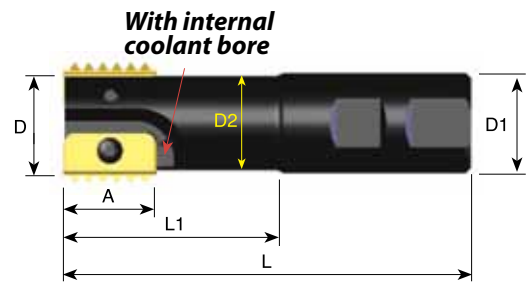

Ordering Code	A	D	D1	D2	L	L1	No. of Inserts	Insert Screw	Torx Key
SR0020H14-2	14	20	20	16	93	41	2	S14	K14
SR0030J21-2	21	30	25	24	108	52	2	S21	K21
SR0040L30-2	30	40	32	30	130	70	2	S30	K30
SR0050M40-2	40	50	40	38	153	78	2	S40	K40

Order example: SR0040L30-2

Multi Insert Toolholders

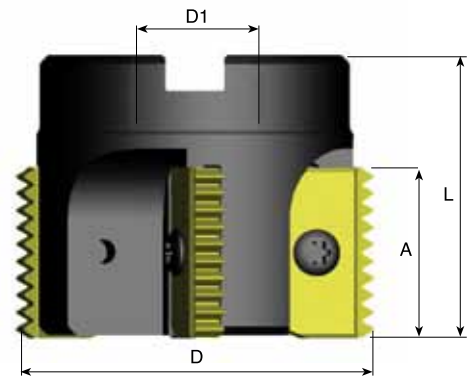

Ordering Code	A	D	D1	L	No. of Inserts	Insert Screw	Torx Key
SR0063C21-5	21	63	22	50	5	S21	K21
SR0063C30-4	30	63	22	50	4	S30	K30
SR0080D30-4	30	80	27	55	4	S30	K30
SR0100D30-4	30	100	32	60	4	S30	K30
SR0100D30-8	30	100	32	60	8	S30	K30
SR0080D40-4	40	80	27	65	4	S40	K40
SR0100E40-4	40	100	32	70	4	S40	K40
SR0100E40-6	40	100	32	70	6	S40	K40

Order example: SR0080D30-4

External Multi Insert Toolholder

- Reduced machining time
- Optimal coolant supply

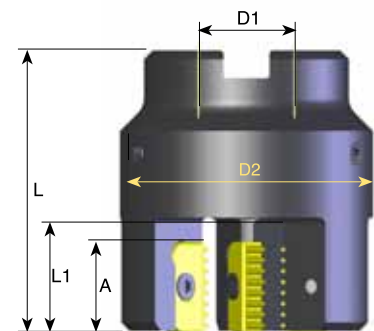
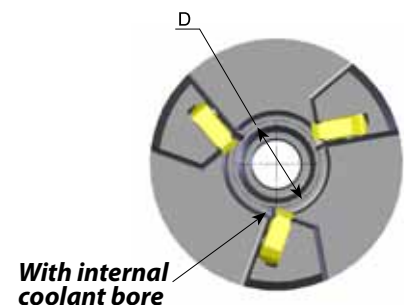
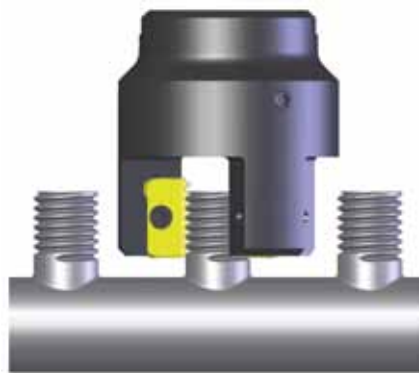

Ordering Code	A	D	D1	D2	L	L1	No. of Inserts	Insert Screw	Torx Key
SLE0020D21-3	21	20	22	58	65	25	3	S21	K21
SLE0030D21-3	21	30	22	68	65	25	3	S21	K21
SLE0045E21-4	21	45	27	83	70	25	4	S21	K21

Order example: SLE0030D21-3

Long Carbide Shank Toolholders

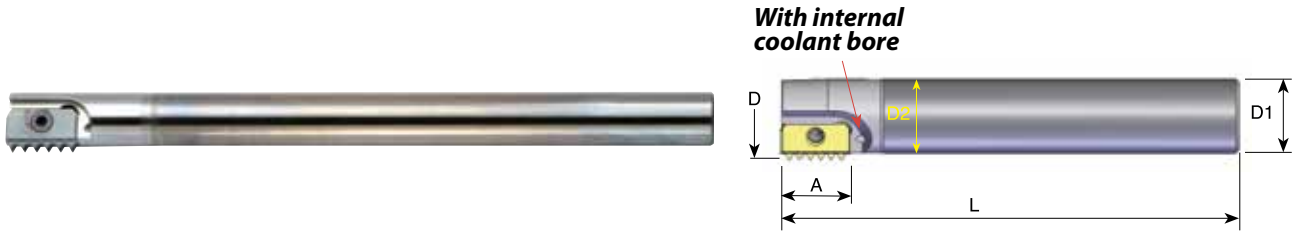



Ordering Code	A	D	D1	D2	L	Insert Screw	Torx Key
SR0010K12C	12	9.9	8	8	125	S12	K12
SR0013H14C	14	13.2	10	10	110	S14	K14
SR0013J14C	14	13.2	10	10	155	S14	K14
SR0015K14C	14	15.2	12	12	175	S14	K14
SR0021K21C	21	21.0	16	16	130	S21	K21
SR0021M21C	21	21.0	16	16	200	S21	K21
SR0027S30C	30	27.0	20	20	270	S30	K30

Order example: SR0015K14C

For holders with long overhang reduce the cutting speed and feed rate between 20% to 40% (depends on workpiece material, pitch and overhang)

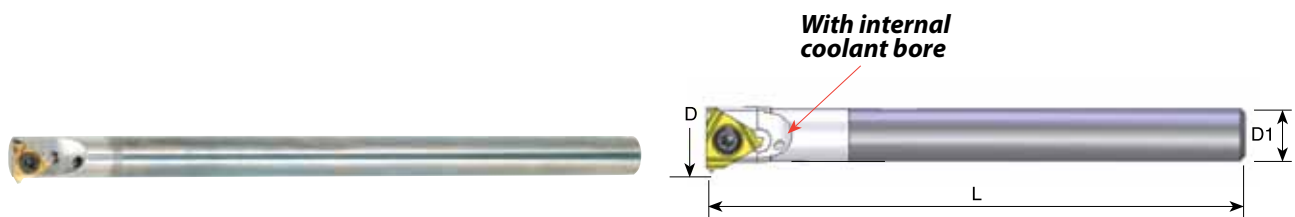
Carbide Shank Toolholders for Single Point Threading



Ordering Code		Pitch Range		D	D1	L	Insert Screw	Torx Key
		mm	TPI					
SR0005D06C	6	0.5-1.25	48-20	6.8	5.0	63	S06	K06
SR0006H08C	8	0.5-1.75	48-14	8.8	6.0	100	S08	K08
* SR0010M11C	11	0.5-2.00	48-11	13.2	10.0	150	S11	K11

For Inserts see the Thread Turning Tools section of this catalogue

For an internal application use an internal R.H. insert.

* For an external application use an external L.H. insert.

D-Thread



Mill-Thread Inserts and Toolholders for machining deep threads

- Improved productivity due to multi-insert toolholders.
- Partial Profile, standard or U-type inserts for a wide range of threads.
- Inserts with three cutting edges, reduces tooling costs.
- Low cutting resistance due to the single point inserts.
- Holder allows for a long overhang and includes internal coolant.
- Same insert and toolholder for both external and internal thread.

Contents:

Page:

Standard Toolholders and Inserts
U-Type Toolholders and Inserts

158
159-160

D-Thread Mill-Thread Inserts & Toolholders for machining deep threads

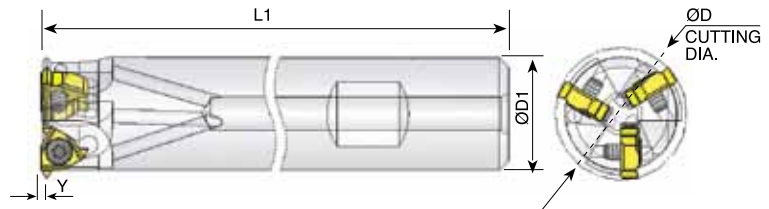

Ordering Code	Insert Size		Y	D	D1	L1	No. of Inserts	Insert Screw	Torx Key
	L	I.C							
SR0023Q11	11	1/4	1	23.5	20	190	3	SE11	K11

Partial 60° Size 11

Ordering Code		Pitch	
		mm	TPI
11 60D	INT.	1.0 - 2.0	24 - 12
	EX.	0.75 - 1.5	32 - 14

Coated Grade: BMA

Partial 55° Size 11

Ordering Code		Pitch TPI
11 55D	INT./EX.	24 - 14

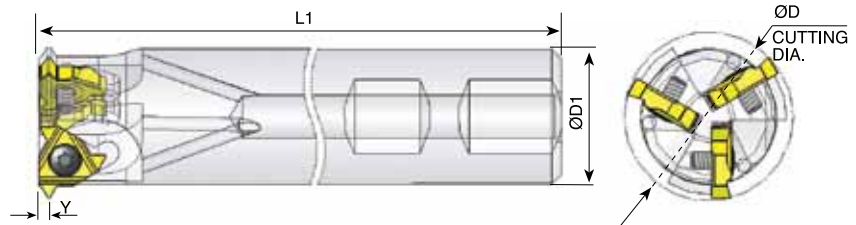
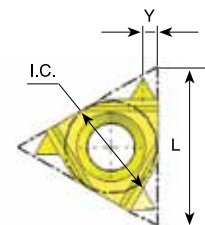

Ordering Code	Insert Size		Y	D	D1	L1	No. of Inserts	Insert Screw	Torx Key
	L	I.C							
SR0031R16	16	3/8	1.8	31	25	225	3	SE16	K16

Partial 60° Size 16

Ordering Code		Pitch	
		mm	TPI
16 60D	INT.	2.5 - 3.5	10 - 7
	EX.	2.0 - 3.0	12 - 8

Coated Grade: BMA

Partial 55° Size 16

Ordering Code		Pitch TPI
16 55D	INT./EX.	12 - 8

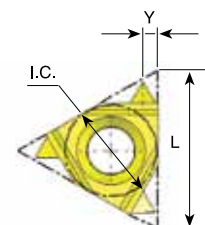

D-Thread Mill-Thread Inserts & Toolholders for machining deep threads

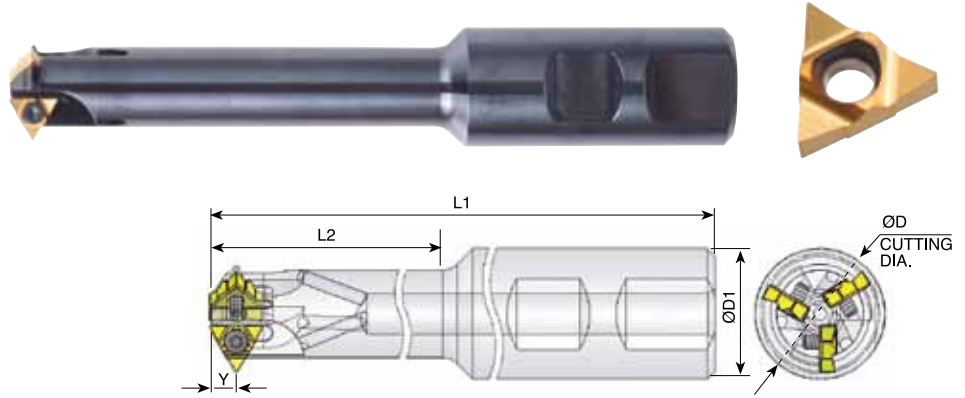

Ordering Code	Insert Size		Y	D	D1	L1	L2	No. of Inserts	Insert Screw	Torx Key
	L	I.C								
SR0023M11U	11U	1/4U	5	23	25	150	88	3	SE11	K11

Partial 60° Size 11U

Ordering Code		Pitch	
		mm	TPI
11U 60D	INT.	2.5 - 4.0	10 - 6
	EX.	2.0 - 3.0	12 - 8
11U 60D-18-12	INT.	1.5 - 2.0	18 - 12
	EX.	1.25 - 1.75	20 - 14

Coated Grade: BMA

Partial 55° Size 11U

Ordering Code		Pitch TPI
11U 55D	INT./EX.	12 - 7

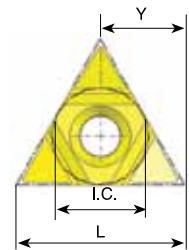

D-Thread Mill-Thread Inserts & Toolholders for machining deep threads

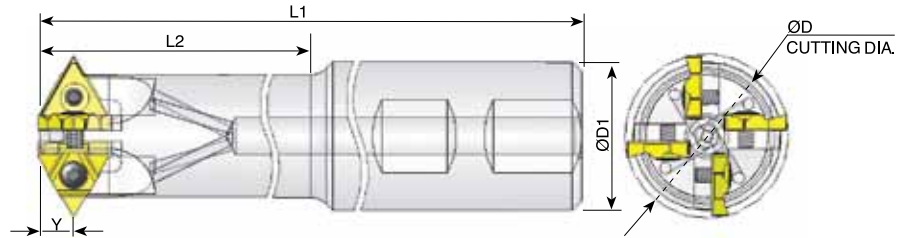

Ordering Code	Insert Size		Y	D	D1	L1	L2	No. of Inserts	Insert Screw	Torx Key
	L	I.C								
SR0035R16U	16U	3/8U	7.6	35.5	32	220	155	4	SE16	K16

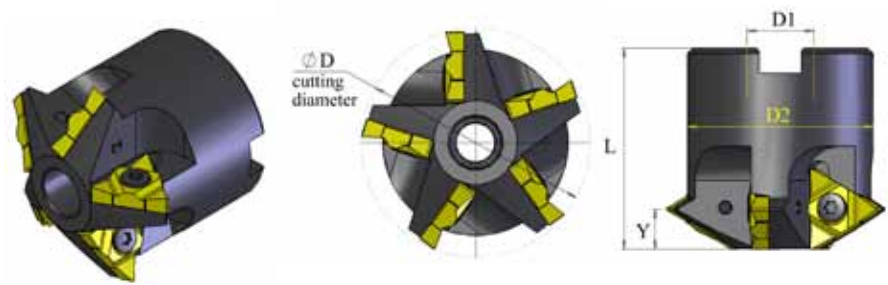

Ordering Code	Insert Size		Y	D	D1	D2	L	No. of Inserts	Insert Screw	Torx Key
	L	I.C								
SR0043B16U-5	16U	3/8U	7.6	43.4	16	35.3	38.1	5	SE16	K16

Partial 60° Size 16U

Ordering Code		Pitch	
		mm	TPI
16U 60D	INT.	4.0 - 6.0	6 - 4
	EX.	3.0 - 5.0	8 - 5
16U 60D-16-8	INT.	1.5 - 3.0	16 - 8
	EX.	1.5 - 2.5	18 - 10

Partial 55° Size 16U

Ordering Code		Pitch TPI
16U 55D	INT./EX.	6 - 4.5

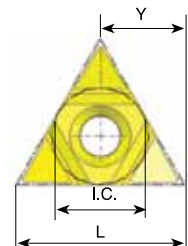

Coated Grade: BMA